

ライトアングタイプ 高電流ソケットピン Right Angle type, High current Socket pin

- Socket pin right angle to wire
- Space saving
- Mating/unmating, Easy Circuit exchange

φ5.0mm/0.197" Right Angle Socket

UJ50-RA-L18-CRMP

Current rating : 25A at 25°C



- ソケットピンが電線に対して90° 方向
- 省スペース
- 脱着、回路切替可能

Acceptable plugpin
: φ5.0mm/φ0.197" dia.

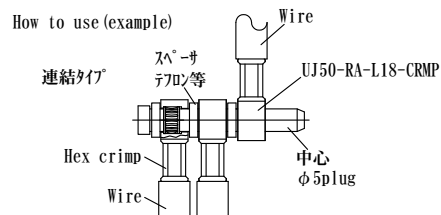
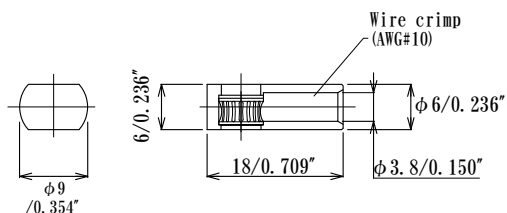
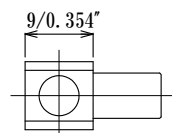

φ6.0mm/0.236" Right Angle Socket

UJ60-RA-L21-CRMP

Current rating : 50A at 25°C



- ソケットピンが電線に対して90° 方向
- 省スペース
- 脱着、回路切替可能

Acceptable plugpin
: φ6.0mm/φ0.236" dia.

